

## DS-D5C75RB/A 75-inch Interactive Flat Panel



The Hikvision Interactive Flat Panel is a kind of newly developed intelligent teaching assistance product which integrates with the latest technologies of touch control, HD display, video processing, network communication, interactive control, sound control. It can be widely applied to the classroom, online teaching, training center, etc.

- UHD 4K display with resolution of 3840 × 2160.
- Anti-glare and anti-blocking design to ensure smooth interaction.
- Dual systems of Android and Windows (Optional) saving cost and easy to use, video conference software are recommended to run under Windows system.
- Quick response, at most 45-points touch control and smooth writing experience.
- Built-in network switch module saves a network switch.
- All-in-one design with tempered glass and intelligent temperature control, making it environmental-friendly and safety-guaranteed, support blue light protection.

## ▪ Specification

Model		DS-D5C75RB/A
<b>Product Model</b>	Product Model	DS-D5C75RB/A
<b>Panel</b>	Glass Thickness	3.2mm
	Glass Bonding Method	Zero Lamination
<b>Display</b>	Screen Size	75 inch
	Backlight	DLED
	Pixel Pitch	0.14325(H) × 0.42975(V) mm
	Resolution	3840 × 2160 @60 Hz
	Brightness	400 cd/m <sup>2</sup> with Brightness sensor
	Color Depth	10bit
	Contrast Ratio	4000:1
	Response Time	8 ms
	Color Gamut	72% NTSC
	Refresh Rate	60 Hz
	Viewing Angle	178°(H)/178°(V)
<b>Optical</b>	Aspect Ratio	16 : 9
<b>Built-in System</b>	Operation System	Android 12.0
	Processor	Quad-core Cortex-A76 × 4 (2.4 GHz) and quad-core Cortex-A55 × 4 (1.8 GHz)
	Memory	8 GB
	Built-in Storage	128 GB
	Panel Type	VA
	HDCP Version	2.0
	Touch Resolution	3840 × 2160
<b>Touch</b>	Type	Infrared Touch Screen
	Touch Point	45 point multi-touch
	Touch Response Time	< 8 ms
	Touch Precision	± 1 mm (≥ 90% touching area)
<b>Processing Performance</b>	Display Color	1.07G
<b>Internal Function</b>	Loudspeaker	Built-in 2 ×15 W+25W loudspeaker;
	Bluetooth	Built-in BLE (Bluetooth Low Energy) module supports Bluetooth 5.1
<b>Interface</b>	Video & Audio Input	HDMI In (HDMI 2.0) × 3, VGA In × 1, DP In (DP 1.2) × 1, Audio In × 1

	Video & audio output	HDMI Out (HDMI 2.0) × 1, Audio Out × 1, SPDIF Out × 1
	Control interface	TOUCH-USB 3.0 × 3, RS232 × 1
	Network Interface	LAN (1000 Mbps) × 2 WIFI AP&Station, 2.4G/5G IEEE 802.11 a/b/g/n/ac 2 × 2 MIMO (2.4 GHz and 5 GHz) authentication protocols WEP, WPA, WPA2, PSK and 802.1X EAP
	Data Transmission Interface	USB 3.0 × 4, USB 2.0 × 1, Type-C × 2 (Type-C supports USB 2.0, DP 1.2, and charging functions; side charging 15 W, front charging 65 W)
<b>Power</b>	Standby Consumption	≤ 0.5 W
	Max. Consumption	< 250W
<b>Working Environment</b>	Working Temperature	0 °C to 40 °C (32 °F to 104°F)
	Working Humidity	10%~90% RH
<b>General</b>	VESA	800 mm × 400 mm (4 × M8-25 mm)
	Power Supply	100 to 240 VAC, 50/60 Hz
	Product dimensions	1713.2 × 1019 × 82.5 mm
	Accessory	Wall mount bracket, hook, user manual, touch writing pen, packing list, 3M touch USB cable, 3M HDMI cable (2.0), 1.5m power cable (European standard), Bluetooth remote control.
	Package Dimensions (W × H × D)	1937 × 264 × 1222 mm
	Net Weight	61.94
	Gross Weight	72.38
	NFC	Support screen mirroring by Android phones.

## ▪ Physical Interface

Interface	Description	Interface	Description
1.SPDIF	SPDIF interface	2.Line OUT	Audio output interface
3.Line IN	Audio input interface	4.VGA IN	Video devices connection interface
5.TYPE-C	Type-C interface	6.DP IN	Display input interface
7.TOUCH-USB 2	Peripheral touch interface	8.HDMI IN 2	HDMI 2 input interface
9.TOUCH-USB	Peripheral touch interface	10.HDMI IN 1	HDMI 1 input interface
11.USB	USB interface	12.MULTI-USB 2	Multi-functional USB interface
13.MULTI-USB 1	Multi-functional USB interface	14.HDMI OUT	HDMI output interface

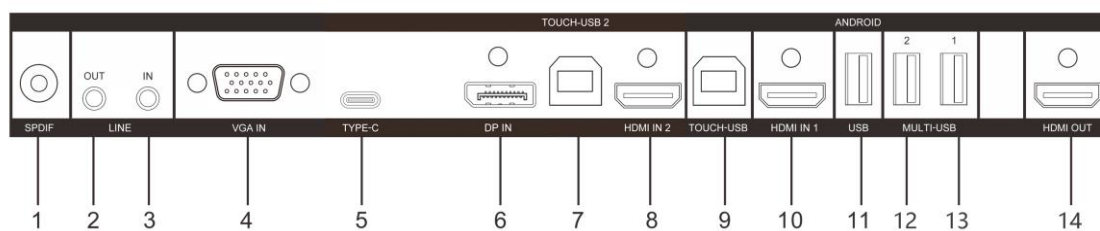

## ▪ Installation

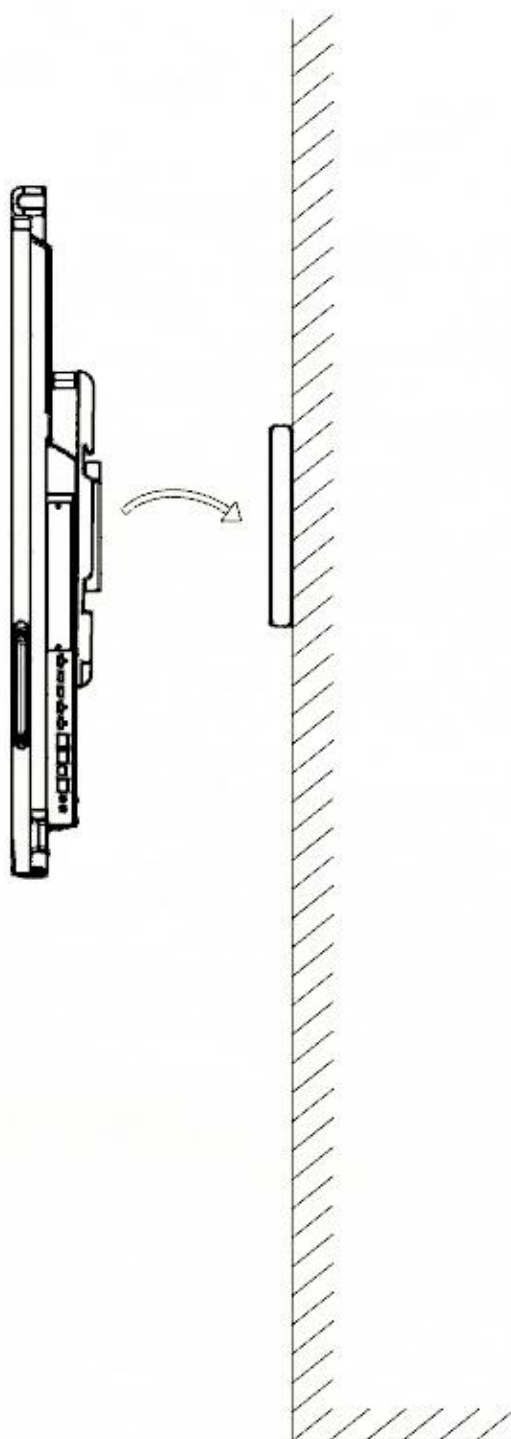

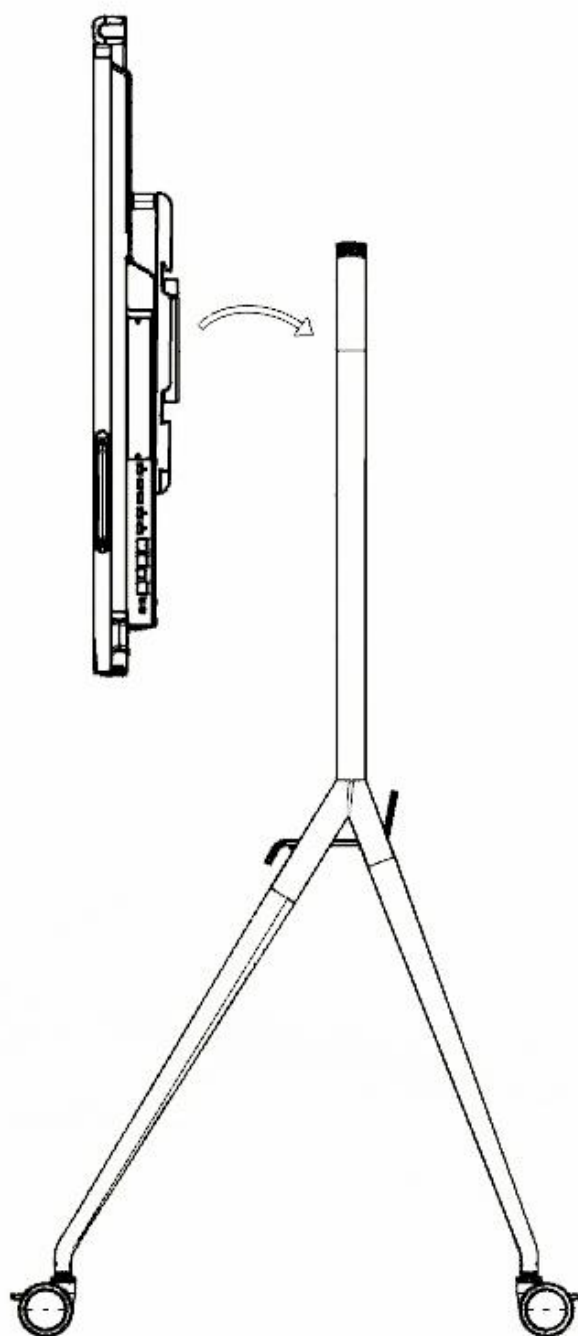

▪ **Available Model**

DS-D5C75RB/A

Dimension

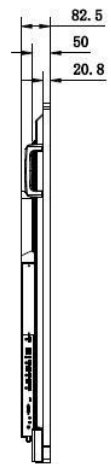
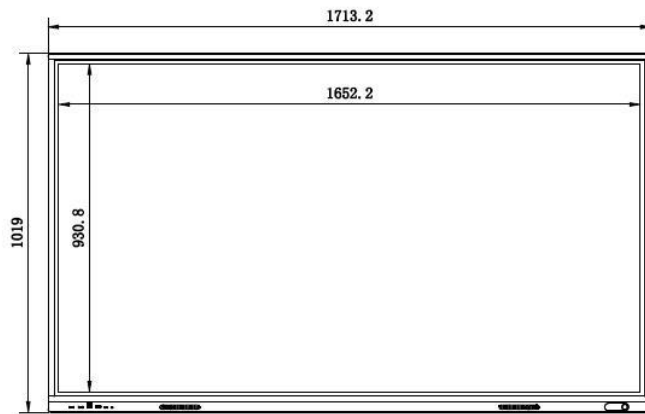
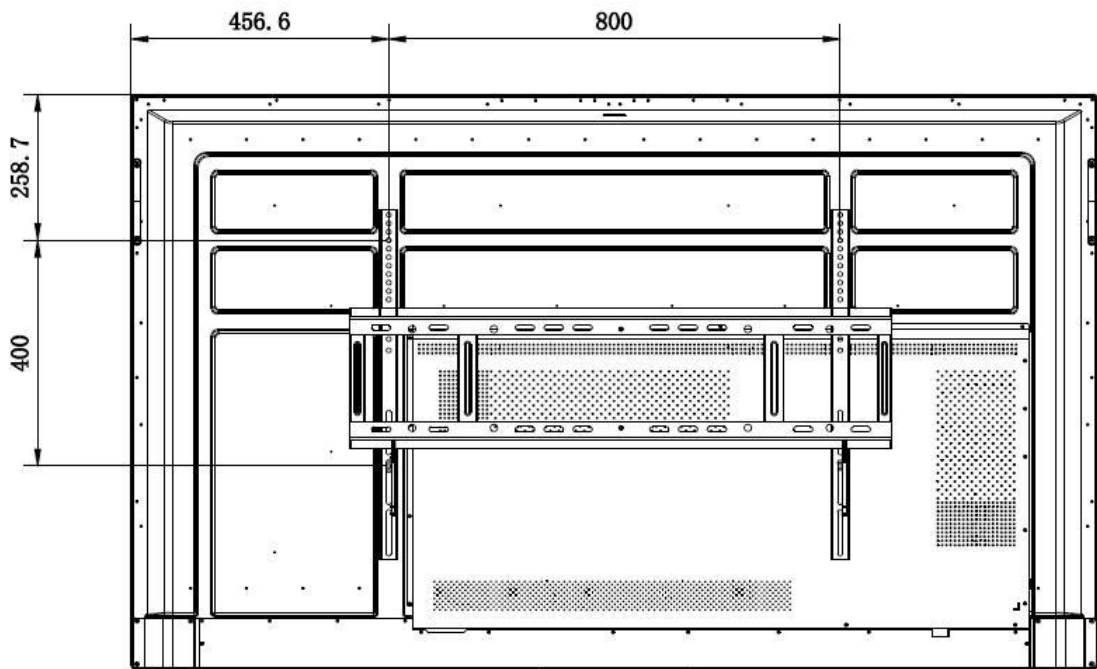

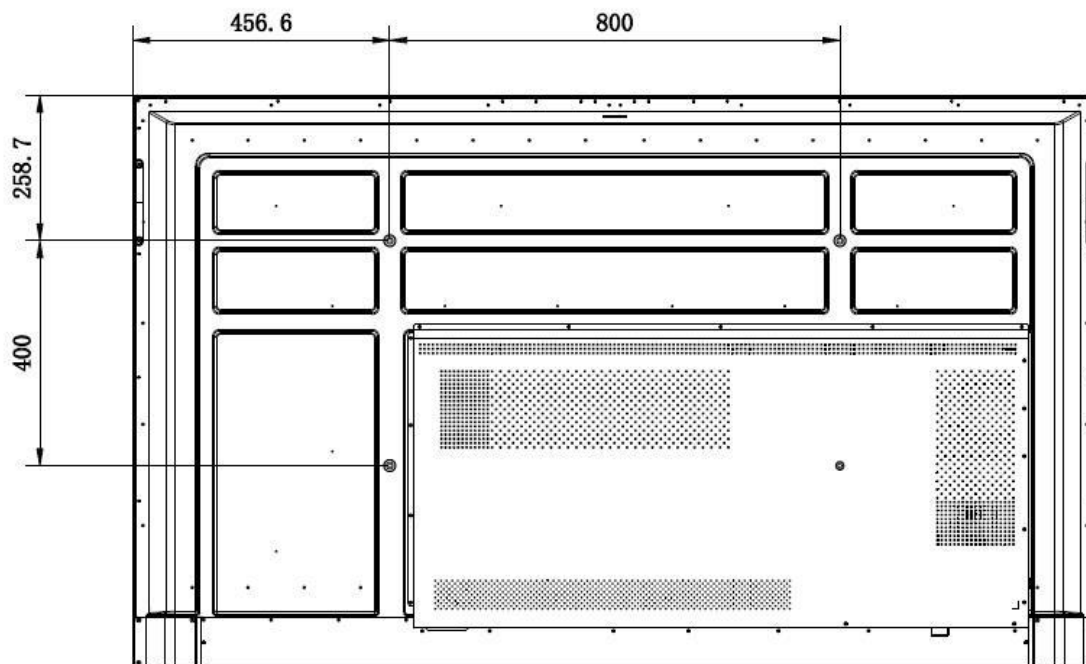

**Headquarters**

No.555 Qianmo Road, Binjiang District,  
Hangzhou 310051, China  
T +86-571-8807-5998  
www.hikvision.com



Follow us on social media to get the latest product and solution information.

